

SP 1200SF

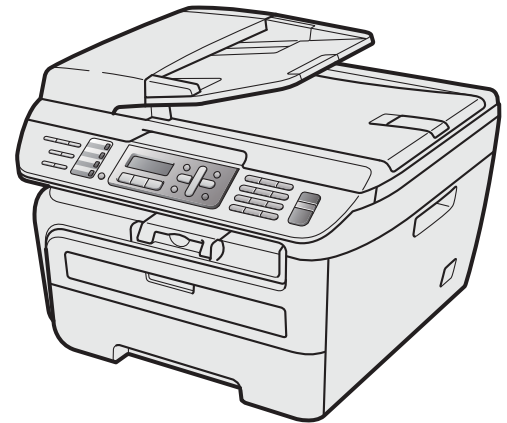

Before you can use the machine, you must set up the hardware and install the driver. Please read this 'Quick Setup Guide' for proper set up and installation instructions.

STEP 1

Setting Up the Machine







STEP 2

Installing the Driver & Software

Setup is Complete!

Keep this 'Quick Setup Guide' and the supplied CD-ROM in a convenient place for quick and easy reference at all times.

Symbols used in this guide

 Warning	 Caution	 Improper Setup
Warnings tell you what to do to prevent possible personal injury.	Cautions specify procedures you must follow or avoid to prevent possible damage to the machine or other objects.	Improper Setup icons alert you to devices and operations that are not compatible with the machine.
 Note	 User's Guide or Software User's Guide	
Notes tell you how you should respond to a situation that may arise or give tips about how the current operation works with other features.	Indicates reference to the User's Guide or Software User's Guide which is on the CD-ROM we have supplied.	

Safety Precautions

To use the machine safely	2
Symbols for the main power switch	4
Important safety instructions	5
Regulations	6
Important Information for Australia	7
Standard telephone and FCC Notices	
These notices are in effect on models sold and used in the United States only	8
Federal Communications Commission (FCC) Declaration of Conformity (USA only)	9
Industry Canada Compliance Statement (Canada only)	9
EQUIPMENT ATTACHMENT LIMITATIONS (Canada only)	9
RESTRICTIONS CONCERNANT LE RACCORDEMENT DE MATÉRIEL	9
Disconnect device	10
Laser safety	10
FDA regulations	10

Getting Started

Carton components for EU	11
Carton components for USA, Canada and Asia/Oceania	12
Control panel (For EU model)	13
Control panel (For USA, Canada and Asia/Oceania model)	14

STEP 1 – Setting Up the Machine

Installing the drum unit and toner cartridge assembly	15
Loading paper in the paper tray	16
Install the power cord and phone line	17
Set Your Country	19
Selecting your language (For EU, USA, Canada and Asia)	19
Setting the date and time	20
Setting your station ID	20
Tone and pulse dialling mode	21
Selecting a receive mode	22
Setting the phone line type (For EU model)	22
Setting up the prefix number	23
Changing the prefix number	24
Setting the LCD contrast	24

Supplied CD-ROM

Supplied CD-ROMs for 'SP 1200SF'	25
Drivers and Utilities for SP 1200SF	25
PaperPort™ 11SE and Documentation for SP 1200SF	25

STEP 2 – Installing the Driver & Software

Installing the TYPE 1200SF Drivers and Utilities	28
Installing ScanSoft™ PaperPort™ 11SE for Windows®	30
View and Installing the documentation	31

Consumables and Options

Consumables	32
-------------------	----

To use the machine safely

Please keep these instructions for later reference and read them before attempting any maintenance.

Choosing a location

Place your machine on a flat, stable surface that is free of vibration and shocks. Put the machine near a telephone wall jack and a standard, grounded AC power outlet. Choose a location where the temperature remains between 50° F and 90.5° F (10° C and 32.5° C) and the humidity is between 20% to 80% (without condensation). Place your machine on a flat, stable surface that is free of vibration. Put the machine near a telephone socket and a standard, grounded electrical socket. Choose a location where the temperature remains between 10° C and 32.5° C and the humidity is between 20% to 80% (without condensation).

- Make sure cables leading to the machine do not constitute a trip hazard.
- Avoid placing your machine on the carpet.
- Do not place near heaters, air conditioners, water, chemicals or refrigerators.
- Do not expose the machine to direct sunlight, excessive heat, moisture or dust.
- Do not connect your machine to electrical sockets controlled by wall switches or automatic timers, or to the same circuit as large appliances that might disrupt the power supply.
- Avoid sources of interference, such as speakers or the base units of cordless phones.

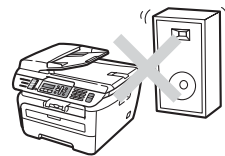
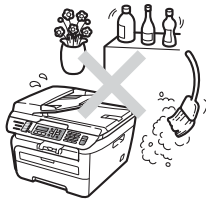
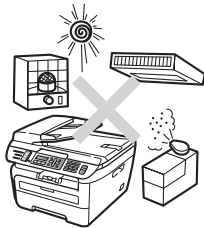

Safety precautions

Please read these instructions before attempting any maintenance, and keep them for later reference. When using your telephone equipment, follow basic safety precautions to reduce the risk of fire, electric shock or personal injury.

- DO NOT use this product near water, or in a damp environment.
- Avoid using this product during an electrical storm. There may be a remote risk of electric shock from lightning.
- We DO NOT advise using an extension lead.
- Never install telephone wiring during a lightning storm. Never install a telephone wall socket in a wet location.
- If any cables become damaged, disconnect your machine, and contact your dealer.
- DO NOT place any objects on the machine, or obstruct the air vents.
- This product should be connected to an adjacent grounded AC power source within the range indicated on the rating label. DO NOT connect it to a DC power source or inverter. If you are not sure, contact a qualified electrician.
- DO NOT dispose of batteries in a fire. They may explode. Check with local codes for possible special disposal instructions.

Warning



Before cleaning the inside of the machine, first unplug the telephone line cord, and then the power cord from the electrical socket.

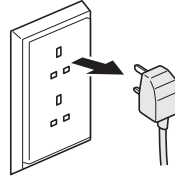

DO NOT use flammable substances, any type of spray or organic solvent/liquids containing alcohol/ammonia to clean the inside or outside of the machine. Doing this may cause a fire or electrical shock. Refer to Routine maintenance for how to clean the machine in the User's Guide.



DO NOT handle the plug with wet hands. Doing this might cause an electrical shock.

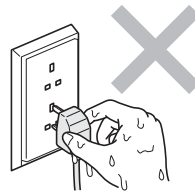

Always make sure the plug is fully inserted.



After you have just used the machine, some internal parts of the machine will be extremely hot. When you open the front or back cover of the machine, DO NOT touch the shaded parts shown in the illustration.

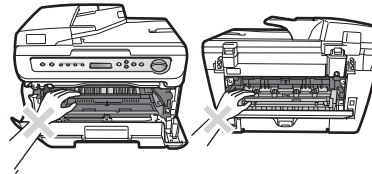

To prevent injuries, be careful not to put your hands on the edge of the machine under the document cover or scanner cover as shown in the illustration.

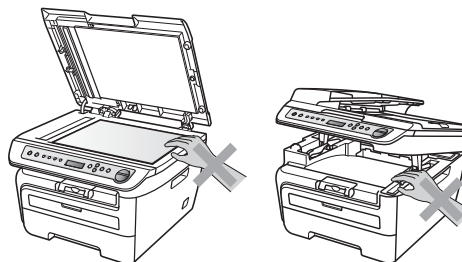

To prevent injuries, DO NOT put your fingers in the area shown in the illustrations.

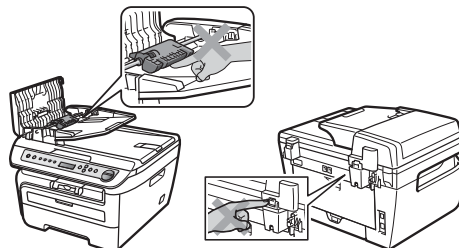

DO NOT use a vacuum cleaner to clean up scattered toner. Doing this might cause the toner dust to ignite inside the vacuum cleaner, potentially starting a fire. Please carefully clean the toner dust with a dry, lint-free cloth and dispose of it according to local regulations.



If moving your machine, use the handholds provided. First making sure to disconnect any cables.



Plastic bags are used in the packaging of your machine. To avoid danger of suffocation, keep these bags away from babies and children.

 **Note**

The fuser unit is marked with a caution label. DO NOT remove or damage the label.

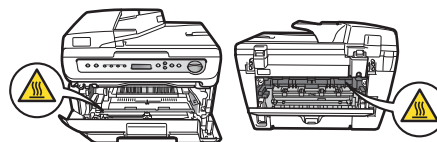



 **Caution**

Be sure to disconnect the plug from the wall outlet and clean the prongs and the area around the prongs at least once a year. Allowing dust to build up on the plug constitutes a fire hazard.

Symbols for the main power switch

In accordance with IEC 60417, this machine uses the following symbols for the main power switch:

-  means POWER ON.
-  means POWER OFF.

 **Note**

When you move the machine, grasp the side handholds that are under the scanner. Do NOT carry the machine by holding it at the bottom.

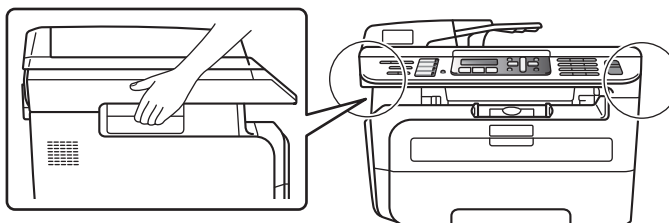

Important safety instructions

- 1 Read all of these instructions.
- 2 Save them for later reference.
- 3 Follow all warnings and instructions marked on the product.
- 4 Unplug this product from the wall socket before cleaning inside of the machine. DO NOT use liquid or aerosol cleaners. Use a damp cloth for cleaning.
- 5 DO NOT place this product on an unstable cart, stand, or table. The product may fall, causing serious damage to the product.
- 6 Slots and openings in the casing at the back or bottom are provided for ventilation. To ensure reliable operation of the product and to protect it from overheating, these openings must not be blocked or covered. The openings should never be blocked by placing the product on a bed, sofa, rug, or other similar surface. This product should never be placed near or over a radiator or heater. This product should never be placed in a built-in installation unless adequate ventilation is provided.
- 7 This product should be connected to an AC power source within the range indicated on the rating label. DO NOT connect it to a DC power source or inverter. If you are not sure, contact a qualified electrician.
- 8 This product should be operated from the type of power source indicated on the label. If you are not sure of the type of power available, call your dealer or local power company.
- 9 This product is equipped with a 3-wire grounded plug. This plug will only fit into a grounded power outlet. This is a safety feature. If you are unable to insert the plug into the outlet, call your electrician to replace your obsolete outlet. DO NOT defeat the purpose of the grounded plug.
- 10 Use only the power cord supplied with this machine.
- 11 DO NOT allow anything to rest on the power cord. DO NOT place this product where people can walk on the cord.
- 12 If an extension cord is used with this product, make sure that the total ampere ratings on the products plugged into the extension cord do not exceed the extension cord ampere rating. Also, make sure that the total of all products plugged into the AC power outlet does not exceed 15 amperes (USA only).
- 13 The power cord, including extensions should be no longer than 5 metres.

DO NOT share the same power circuit with other high powered appliances, such as an air conditioner, copier, shredder or similar devices. If you cannot avoid using the printer with these appliances, we recommend that you use a high-frequency noise filter.

Use a voltage regulator if the power source is not stable.
- 14 DO NOT place anything in front of the machine that will block received faxes. DO NOT place anything in the path of received faxes.
- 15 Wait until pages have exited the machine before picking them up.
- 16 Never push objects of any kind into this product through cabinet slots, since they may touch dangerous voltage points or short out parts resulting in the risk of fire or electric shock. Never spill liquid of any kind on the product. Do not attempt to service this product yourself because opening or removing covers may expose you to dangerous voltage points and other risks and may void your warranty. Refer all servicing to your service representative.
- 17 Unplug this product from the power socket and refer all servicing to Ricoh Authorized Service Personnel under the following conditions:
 - When the power cord is damaged or frayed.
 - If liquid has been spilled into the product.
 - If the product has been exposed to rain or water.
 - If the product does not operate normally when the operating instructions are followed. Adjust only those controls that are covered by the operating instructions. Incorrect adjustment of other controls may result in damage and will often require extensive work by a qualified technician to restore the product to normal operation.
 - If the product has been dropped or the casing has been damaged.
 - If the product exhibits a distinct change in performance, indicating a need for service.
- 18 To protect your product against power surges, we recommend the use of a power protection device (Surge Protector).

19 To reduce the risk of fire, electric shock and injury to people, note the following:

- DO NOT use this product near appliances that use water, a swimming pool or in a wet basement.
- DO NOT use the machine during an electrical storm (there is the remote possibility of an electrical shock) or to report a gas leak in the vicinity of the leak.
- Do not dispose of batteries in a fire. They may explode. Check with local codes for possible special disposal instructions.

20 Caution - To reduce the risk of fire, use only No.26 AWG or larger telecommunication line cord.

Regulations

IEC 60825-1:2007 Specification

This machine is a Class 1 laser product as defined in IEC 60825-1:2007 specifications. The label shown below is attached in countries where required.



This machine has a Class 3B Laser Diode which emits invisible laser radiation in the Scanner Unit. The Scanner Unit should not be opened under any circumstances.

Laser Diode

Wave length: 780 - 800 nm

Output: 10 mW max.

Laser Class: Class 3B

Warning

Use of controls, adjustments or performance of procedures other than those specified in this manual may result in hazardous radiation exposure.

Disconnect device

This product must be installed near an AC power outlet electrical socket that is easily accessible. In case of emergencies, you must disconnect the power cord from the AC power outlet electrical socket to shut off power completely.

Wiring information (U.K. only)

If you need to replace the plug fuse, fit a fuse that is approved by ASTA to BS1362 with the same rating as the original fuse.

Always replace the fuse cover. Never use a plug that does not have a cover. If in any doubt, call a qualified electrician.

Warning - This printer must be earthed.

The wires in the mains lead are coloured in line with the following code:

- Green and Yellow: Earth
- Blue: Neutral
- Brown: Live

Radio interference

This product complies with EN55022 (CISPR Publication 22)/Class B. When connecting the machine to a computer, ensure that you use the following interface cables.

A USB cable which must not exceed 2.0 metres in length.

Recycling information in accordance with the WEEE (2002/96/EC) and Battery (2006/66/EC) Directives



Product mark



Battery mark

European Union only

The product/battery is marked with one of the above recycling symbols. It indicates that at the end of the life of the product/battery, you should dispose of it separately at an appropriate collection point and not place it in the normal domestic waste stream. For products with user replaceable batteries please refer to the users guide for replacement instructions.

All Other Users

If you wish to discard this product, please contact your local authorities, the shop where you bought this product, your local dealer or sales/service representatives.

International ENERGY STAR® Qualification Statement

The purpose of the International ENERGY STAR® Program is to promote the development and popularization of energy-efficient office equipment. As an ENERGY STAR® Partner, Ricoh Company, Ltd. has determined that this product meets the ENERGY STAR® guidelines for energy efficiency.



Important Information for Australia

IMPORTANT-For Your Safety

To ensure safe operation the three-pin plug supplied must be inserted only into a standard three-pin power point which is effectively grounded through the normal household wiring.

Extension cords used with the equipment must be three-conductor and be correctly wired to provide connection to ground. Incorrectly wired extension cords are a major cause of fatalities.

The fact that the equipment operates satisfactorily does not imply that the power is grounded and that the installation is completely safe. For your safety, if in any doubt about the effective grounding of the power, consult a qualified electrician.

Standard telephone and FCC Notices

These notices are in effect on models sold and used in the United States only

When programming emergency numbers or making test calls to emergency numbers:

- Remain on the line and briefly explain to the dispatcher the reason for the call before hanging up.
- Perform these activities in the off-peak hours, such as early morning or late evening.

This equipment complies with Part 68 of the FCC rules and the requirements adopted by the ACTA. On the backside of this equipment is a label that contains, among other information, a product identifier in the format US: AAAEQ##TXXXX. If requested, this number must be provided to the telephone company. You may safely connect this equipment to the telephone line by means of a standard modular jack, USOC RJ11C.

A plug and jack used to connect this equipment to the premises wiring and telephone network must comply with the applicable FCC Part 68 rules and requirements adopted by the ACTA. A compliant telephone cord and modular plug is provided with this product. It is designed to be connected to a compatible modular jack that is also compliant. See installation instructions for details.

The REN is used to determine the number of devices that may be connected to a telephone line. Excessive RENs on a telephone line may result in the devices not ringing in response to an incoming call. In most but not all areas, the sum of RENs should not exceed five (5.0). To be certain of the number of devices that may be connected to a line, as determined by the total RENs, contact the local telephone company. The REN for this product is part of the product identifier that has the format US:AAAEQ##TXXXX. The digits represented by ## are the REN without a decimal point (e.g., 06 is a REN of 0.6). For earlier products, the REN is separately shown on the label.

If this equipment causes harm to the telephone network, the telephone company will notify you in advance that temporary discontinuance of service may be required. But if advance notice isn't practical, the telephone company will notify the customer as soon as possible. Also, you will be advised of your right to file a complaint with the FCC if you believe it is necessary.

The telephone company may make changes in its facilities, equipment, operations or procedures that could affect the operation of the equipment. If this happens the telephone company will provide advance notice in order for you to make necessary modifications to maintain uninterrupted service.

If trouble is experienced with this equipment, for repair or warranty information, please contact Ricoh Americas Corporation CUSTOMER SUPPORT DEPT. at 1-800-FASTFIX.

If the equipment is causing harm to the telephone network, the telephone company may request that you disconnect the equipment until the problem is resolved.

Connection to party line service is subject to state tariffs. Contact the state public utility commission, public service commission or corporation commission for information.

If your home has specially wired alarm equipment connected to the telephone line, ensure the installation of this equipment does not disable your alarm equipment. If you have questions about what will disable alarm equipment, call your telephone company or a qualified installer.

If you are not able to solve a problem with your machine, please contact RICOH CORP. CUSTOMER SUPPORT DEPT. at 1-800-FASTFIX.

Warning

- For protection against the risk of electrical shock, always disconnect all cables from the wall outlet before servicing, modifying or installing the equipment.
- This equipment may not be used on coin service lines provided by the telephone company or connected to party lines.
- Ricoh cannot accept any financial or other responsibilities that may be the result of your use of this information, including direct, special or consequential damages. There are no warranties extended or granted by this document.
- This machine has been certified to comply with FCC standards, which are applied to the USA only. A grounded plug should be plugged into a grounded AC power outlet after checking the rating of the local power supply for the machine to operate properly and safely.

Federal Communications Commission (FCC) Declaration of Conformity (USA only)

Responsible Party:

Ricoh Americas Corporation
Address: 5 Dedrick Place, West Caldwell,
NJ 07006 Telephone number: 973-882-2000

declares, that the products

Product Name:

Laser Multi Function

Model Number:

SP 1200SF

comply with Part 15 of the FCC Rules. Operation is subject to the following two conditions: (1) This device may not cause harmful interference, and (2) this device must accept any interference received, including interference that may cause undesired operation.

This equipment has been tested and found to comply with the limits for a Class B digital device, pursuant to Part 15 of the FCC Rules. These limits are designed to provide reasonable protection against harmful interference in a residential installation. This equipment generates, uses, and can radiate radio frequency energy and, if not installed and used in accordance with the instructions, may cause harmful interference to radio communications. However, there is no guarantee that interference will not occur in a particular installation. If this equipment does cause harmful interference to radio or television reception, which can be determined by turning the equipment off and on, the user is encouraged to try to correct the interference by one or more of the following measures:

- Reorient or relocate the receiving antenna.
- Increase the separation between the equipment and receiver.
- Connect the equipment into an outlet on a circuit different from that to which the receiver is connected.
- Consult the dealer or an experienced radio/TV technician for help.

Caution

Changes or modifications not expressly approved by the party responsible for compliance could void the user's authority to operate the equipment.

Important - about the interface cable

A shield interface cable should be used to ensure compliance with the limits for a Class B digital device.

Industry Canada Compliance Statement (Canada only)

This Class B digital apparatus complies with Canadian ICES-003.

Cet appareil numérique de la classe B est conforme à la norme NMB-003 du Canada.

EQUIPMENT ATTACHMENT LIMITATIONS (Canada only)

NOTICE

This product meets the applicable Industry Canada technical specifications.

NOTICE

The Ringer Equivalence Number is an indication of the maximum number of devices allowed to be connected to a telephone interface.

The termination on an interface may consist of any combination of devices subject only to the requirement that the sum of the RENs of all the devices does not exceed five.

RESTRICTIONS CONCERNANT LE RACCORDÉMENT DE MATÉRIEL

AVIS

Le présent matériel est conforme aux spécifications techniques d'Industrie Canada applicables au matériel terminal.

AVIS

L'indice d'équivalence de la sonnerie (IES) indique le nombre maximal de terminaux qui peuvent être raccordés à une interface téléphonique. La terminaison d'une interface peut consister en une combinaison quelconque de dispositifs, à la seule condition que la somme de l'IES de tous les dispositifs n'excède pas cinq.

Disconnect device

This product must be installed near an AC power outlet electrical socket that is easily accessible. In case of emergencies, you must disconnect the power cord from the electrical socket AC power outlet to shut off power completely.

Laser safety

This machine complies with the requirements of IEC60825-1+A2:2001 for class 1 laser product. This equipment is certified as a Class 1 laser product under the U.S. Department of Health and Human Services (DHHS) Radiation Performance Standard according to the Radiation Control for Health and Safety Act of 1968. This means that the equipment does not produce hazardous laser radiation. Since radiation emitted inside the equipment is completely confined within protective housings and external covers, the laser beam cannot escape from the machine during any phase of user operation.

FDA regulations

U.S. Food and Drug Administration (FDA) has implemented regulations for laser products manufactured on and after August 2, 1976. Compliance is mandatory for products marketed in the United States. One of the following labels on the back of the machine indicates compliance with the FDA regulations and must be attached to laser products marketed in the United States.

Manufactured:

RICOH COMPANY LTD,
3-6, Naka-magome 1-Chome Ohta-ku,
Tokyo 143-8555, Japan
Complies with FDA performance standards for laser products except for deviations pursuant to Laser Notice No. 50, dated June 24, 2007.

Warning

Use of controls, adjustments or performance of procedures other than those specified in this manual may result in hazardous invisible radiation exposure.

Internal laser radiation

Max. Radiation Power	10 mW
Wave Length	780 - 800 nm
Laser Class	Class 3B

International ENERGY STAR® Qualification Statement

The purpose of the International ENERGY STAR® Program is to promote the development and popularization of energy-efficient office equipment. As an ENERGY STAR® Partner, Ricoh Company, Ltd. has determined that this product meets the ENERGY STAR® guidelines for energy efficiency.







Carton components for EU

Carton components may vary from one country to another.

Save all packing materials and the carton in case for any reason you must ship your machine.

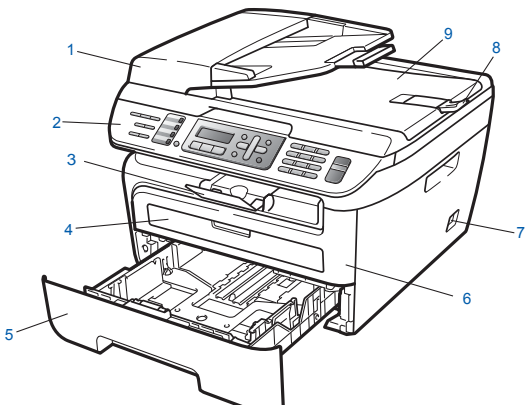
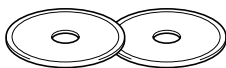
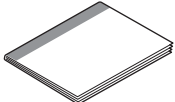
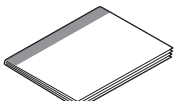
Warning

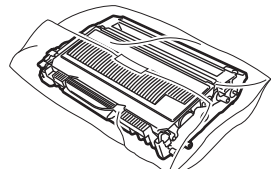
Plastic bags are used in the packaging of your machine. To avoid danger of suffocation, please keep these bags away from babies and children.

 <ol style="list-style-type: none"> 1. Automatic Document Feeder (ADF) 2. Control panel 3. Face-down Output Tray Support 4. Manual Feed Slot 5. Paper Tray 6. FrontCover 7. Power Switch 8. ADF Document Output Support Flap 9. Document Cover 	 <p>CD-ROMs For Drivers For User Guide and Paper Port™</p>	
	 <p>Quick Install Guide</p>	
	 <p>Safety booklet</p>	
 <p>AC Power Cord</p>	 <p>Drum Unit Assembly (including Toner Cartridge)</p>	 <p>USB cable</p>

Do NOT connect the interface cable at this time. Connecting the interface cable is done during the software installation process.

■ **USB interface cable**

Please make sure you use a USB 2.0 interface cable that is no longer than 6 feet (2 metres). When you use a USB cable, make sure you connect it to the USB port of your computer and not to a USB port on a keyboard or non-powered USB hub.

■ **Carton components may differ from one country to another.**





Carton components for USA, Canada and Asia/Oceania

Carton components may vary from one country to another.

Save all packing materials and the carton in case for any reason you must ship your machine.

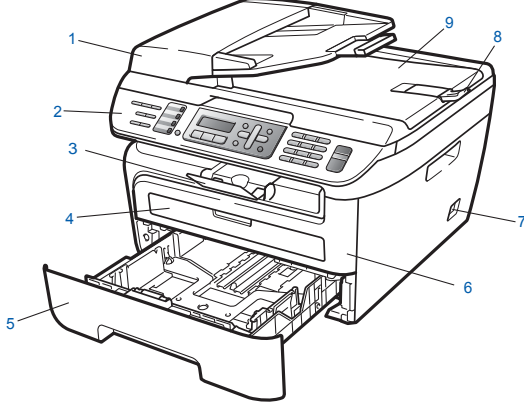
Warning

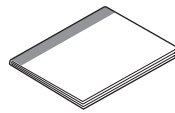
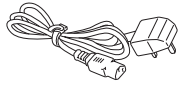
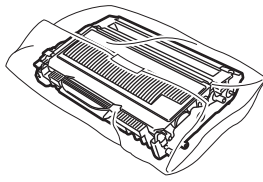
Plastic bags are used in the packaging of your machine. To avoid danger of suffocation, please keep these bags away from babies and children.

 <ol style="list-style-type: none">1. Automatic Document Feeder (ADF)2. Control panel3. Face-down Output Tray Support4. Manual Feed Slot5. Paper Tray6. Front Cover7. Power Switch8. ADF Document Output Support Flap9. Document Cover	 <p>CD-ROMs For Drivers For User Guide and Paper Port™</p>	
	 <p>Quick Setup Guide</p>	
	 <p>User's Guide (Asia/Oceania only)</p>	
 <p>AC Power Cord</p>	 <p>Drum Unit Assembly (including Toner Cartridge)</p>	 <p>USB cable</p>

Do NOT connect the interface cable at this time. Connecting the interface cable is done during the software installation process.

■ **USB interface cable**

Please make sure you use a USB 2.0 interface cable that is no longer than 6 feet (2 metres). When you use a USB cable, make sure you connect it to the USB port of your computer and not to a USB port on a keyboard or non-powered USB hub.

■ **Carton components may differ from one country to another.**

Control panel (For EU model)

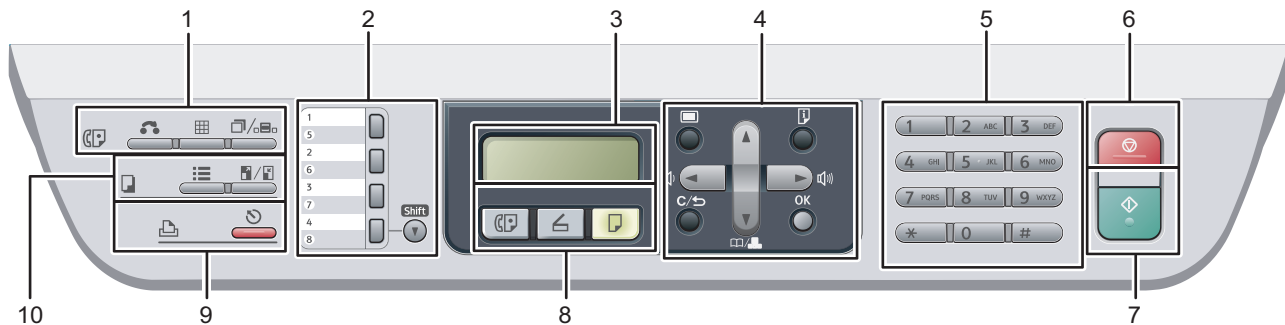

 For the details of the control panel, see *Control panel overview* in Chapter 1 of the User's Guide.

1 Fax and telephone keys:

Hook

Press before dialing if you want to make sure a fax machine will answer, and then press Start.

Also, press this key after you pick up the handset of an external telephone during the F/T ring (fast double-rings).

Resolution

Sets the resolution when sending a fax.

Redial/Pause

Redials the last number called. It also inserts a pause when programming quick dial numbers or when dialling a number manually.

2 One Touch keys

These 4 keys give you instant access to 8 previously stored numbers.

Shift

Lets you access One Touch numbers 5 to 8 when held down.

3 LCD

Displays messages to help you set up and use your machine.

4 Menu keys:

Menu

Lets you access the Menu to program your settings in this machine.



Clear/Back

Deletes entered data or lets you cancel the current setting.

OK

Lets you store your settings in the machine.

Volume keys

 or 

Press to scroll backwards or forwards through menu selections. Press to change the volume when in fax or standby mode.

 or 

Press to scroll through the menus and options.

Search/Speed Dial

Lets you look up numbers that are stored in the dialling memory. It also lets you dial stored numbers by pressing a three-digit number.

Reports

Print the Transmission Verification Report, Help List, Tel Index List, Fax Journal, User Settings and Order Form.

5 Dial pad

Use these keys to dial telephone and fax numbers and as a keyboard for entering information into the machine. The # key temporarily switches the dialling mode from Pulse to Tone during a telephone call.

6 Stop/Exit

Stops an operation or exits from a menu.

7 Start

Lets you start sending faxes, making copies or scanning.

8 Mode keys:

Fax

Puts the machine in Fax mode.

Scan

Puts the machine in Scan mode. (For details about scanning, see the *Software User's Guide on the CD-ROM*.)

Copy

Puts the machine in Copy mode.

9 Print keys:

Job Cancel

Cancels a programmed print job and clears it from the machine's memory.

To cancel multiple print jobs, hold down this key until the LCD shows *Job Cancel (All)*.

10 Copy keys:

Options

You can quickly and easily choose temporary settings for copying.

Enlarge/Reduce

Reduces or enlarges copies.

Control panel (For USA, Canada and Asia/Oceania model)

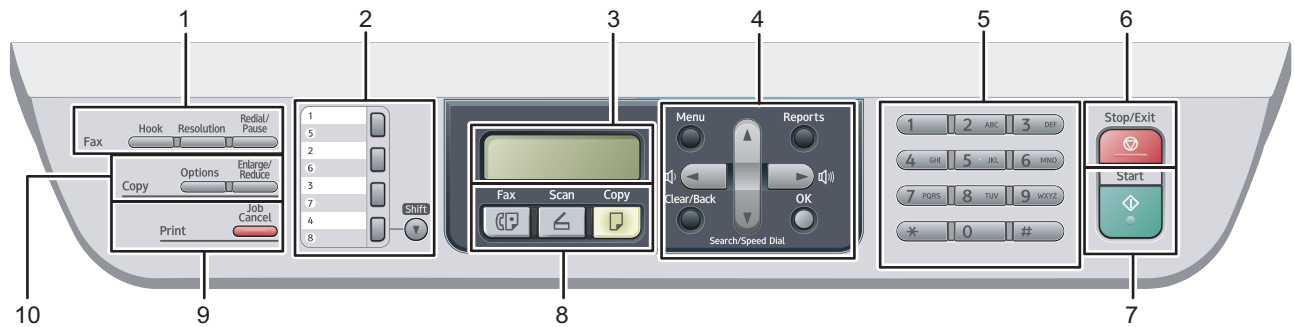

For the details of the control panel, see Control panel overview in Chapter 1 of the User's Guide.

1 Fax and telephone keys:

Hook

Press before dialing if you want to make sure a fax machine will answer, and then press Start.

Also, press this key after you pick up the handset of an external telephone during the F/T ring (fast double-rings).

Resolution

Sets the resolution when sending a fax.

Redial/Pause

Redials the last number called. It also inserts a pause when programming quick dial numbers or when dialling a number manually.

2 One Touch keys

These 4 keys give you instant access to 8 previously stored numbers.

Shift

Lets you access One Touch numbers 5 to 8 when held down.

3 LCD

Displays messages to help you set up and use your machine.

4 Menu keys:

Menu

Lets you access the Menu to program your settings in this machine.

Clear/Back

Deletes entered data or lets you cancel the current setting.

OK

Lets you store your settings in the machine.

Volume keys

◀ or ▶

Press to scroll backwards or forwards through menu selections. Press to change the volume when in fax or standby mode.

▲ or ▼

Press to scroll through the menus and options.

▼ Search/Speed Dial

Lets you look up numbers that are stored in the dialling memory. It also lets you dial stored numbers by pressing a three-digit number.

Reports

Print the Transmission Verification Report, Help List, Tel Index List, Fax Journal, User Settings and Order Form.

5 Dial pad

Use these keys to dial telephone and fax numbers and as a keyboard for entering information into the machine.

The # key temporarily switches the dialling mode from Pulse to Tone during a telephone call.

6 Stop/Exit

Stops an operation or exits from a menu.

7 Start

Lets you start sending faxes, making copies or scanning.

8 Mode keys:

Fax

Puts the machine in Fax mode.

Scan

Puts the machine in Scan mode. (For details about scanning, see the *Software User's Guide on the CD-ROM*.)

Copy

Puts the machine in Copy mode.

9 Print keys:

Job Cancel

Cancels a programmed print job and clears it from the machine's memory.

To cancel multiple print jobs, hold down this key until the LCD shows Job Cancel (All).

10 Copy keys:

Options

You can quickly and easily choose temporary settings for copying.

Enlarge/Reduce

Reduces or enlarges copies.

STEP 1 Setting Up the Machine

1 Installing the drum unit and toner cartridge assembly

⊘ Improper Setup

DO NOT connect the interface cable.
Connecting the interface cable is done when installing the driver.

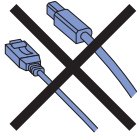

1 Open the front cover.

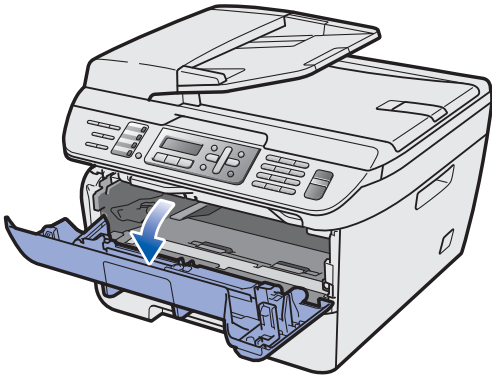

2 Unpack the drum unit and toner cartridge assembly.

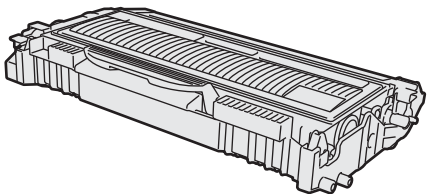

3 Gently shake it from side to side several times to distribute the toner evenly inside the assembly.

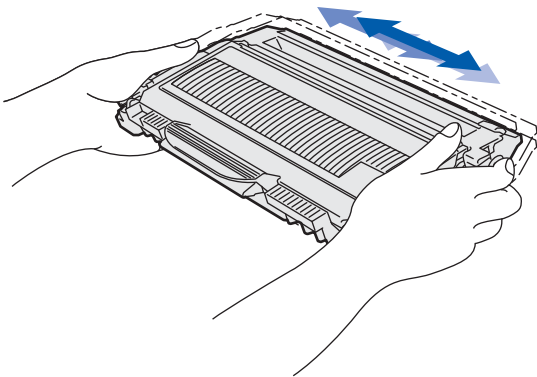

4 Put the drum unit and toner cartridge assembly into the machine.

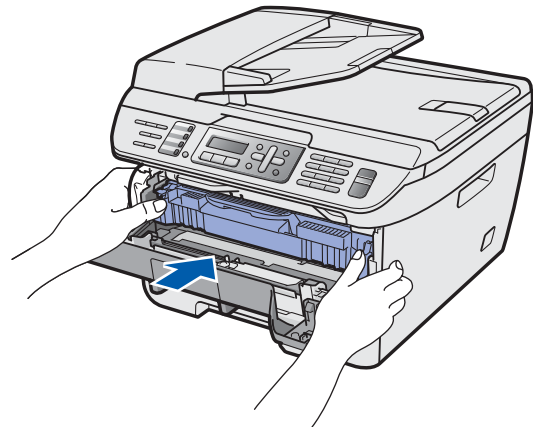
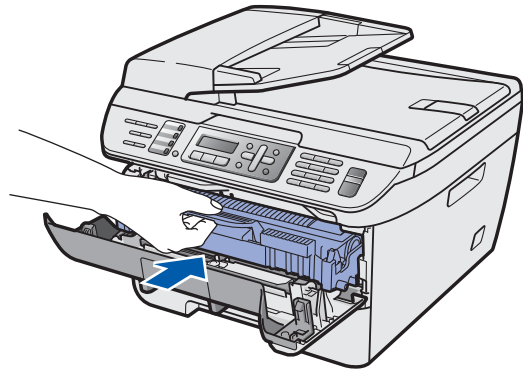

5 Close the front cover of the machine.

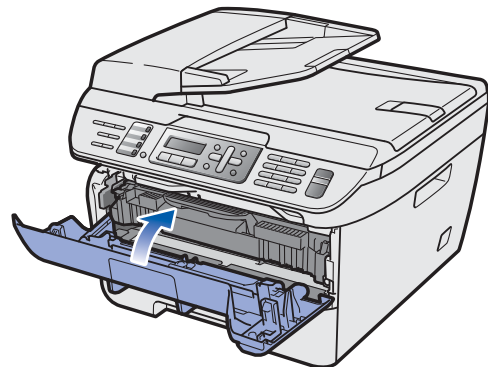

2 Loading paper in the paper tray

- 1 Pull the paper tray completely out of the machine.

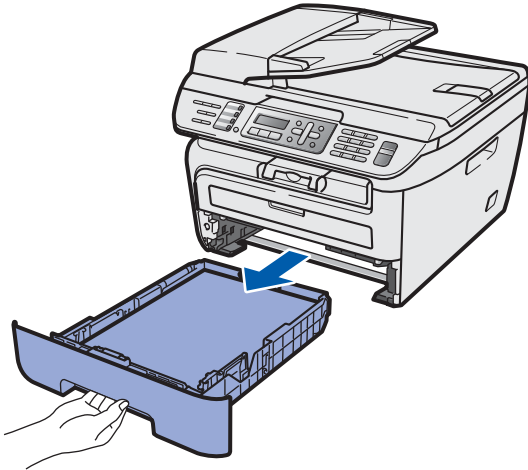

- 2 While pressing the green paper-guide release lever, slide the paper guides to fit the paper size you are using. Make sure that the guides are firmly in the slots.

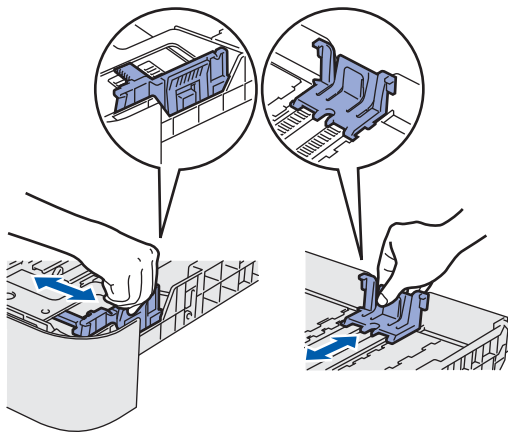

Note

(For USA/Canada and Asia)

For Legal size paper, press the release button in the bottom of the paper tray and then pull out the back of the paper tray. (Legal size paper is not available in some regions.)

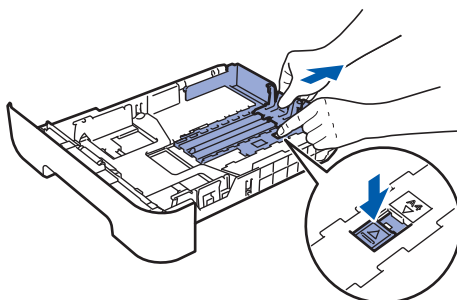

- 3 Fan the stack of paper well to avoid paper jams and misfeeds.

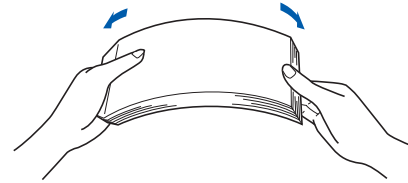

- 4 Put paper in the paper tray. Make sure that the paper is flat in the tray and below the maximum paper mark (1).

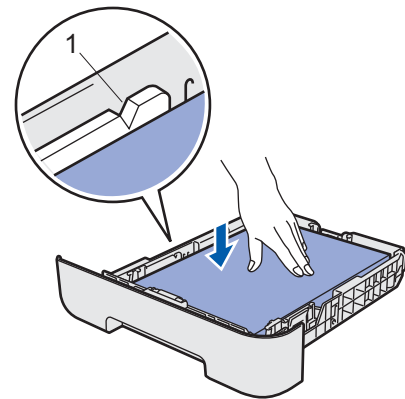

! Caution

Make sure the paper guides touch the sides of the paper so it will feed properly. If you do not do this, it may cause damage to your machine.

- 5 Put the paper tray firmly back into the machine. Make sure that it is completely inserted into the machine.

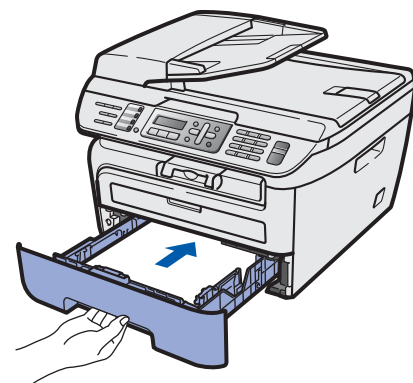

3 Install the power cord and phone line

- 1 Make sure that the machine's power switch is off. Connect the AC power cord to the machine.

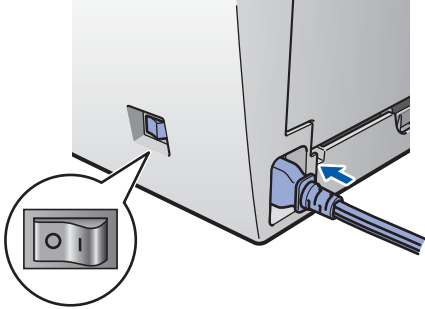

- 2 Plug the AC power cord into an AC outlet. Turn the power switch on.

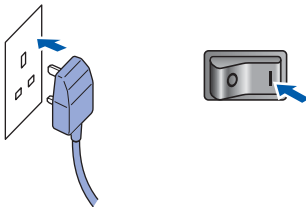

- 3 Connect one end of the telephone line cord to the socket on the machine marked **LINE** and the other end to a modular wall socket.

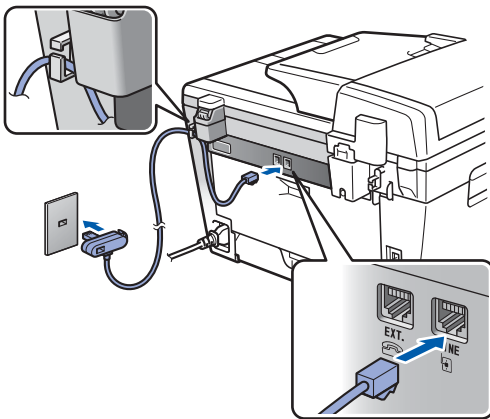

Warning

- The machine must be fitted with an earthed plug.
- Since the machine is grounded through the power outlet, you can protect yourself from potentially hazardous electrical conditions on the telephone network by keeping the power cord connected to your machine when you connect it to a telephone line. Similarly, you can protect yourself when you want to move your machine by disconnecting the telephone line first and then the power cord.

Note

If you are sharing one phone line with an external telephone, connect it as shown below.

Type A

For the countries such as Spain, Netherlands, Portugal, Poland, Hungary, Czech, Norway, USA, Canada and Asia/Oceania.

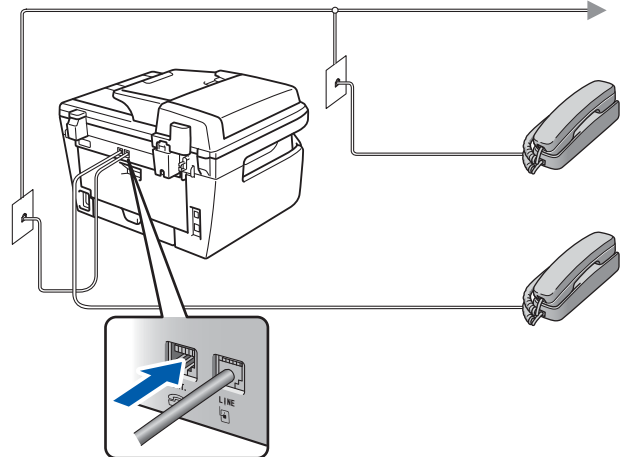

Type B

For the countries such as UK, France, Italy, Belgium, Sweden, Denmark and Finland.

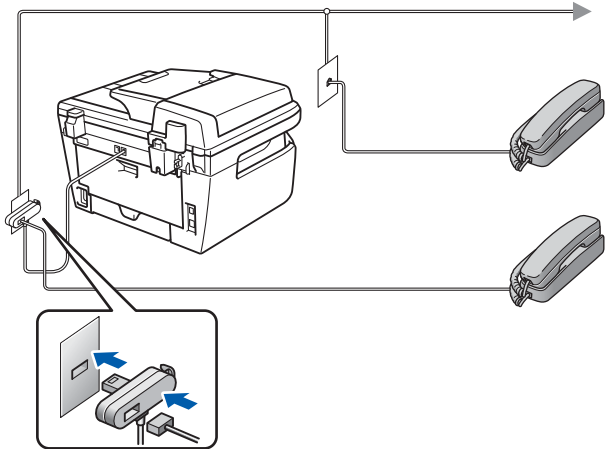

Type C

For Germany

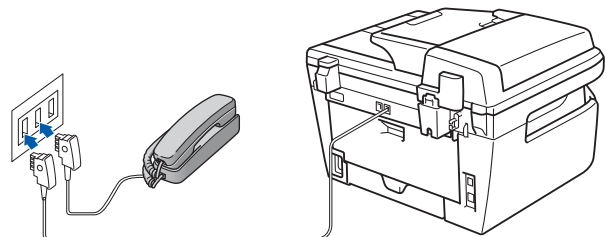

STEP 1

Setting Up the Machine

Type D For Switzerland

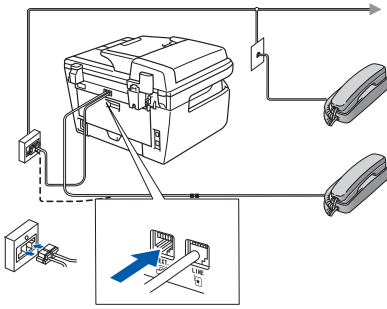

Note

If you are sharing one phone line with an external telephone answering device, connect it as shown below.

Type A

For the countries such as Spain, Netherlands, Portugal, Poland, Hungary, Czech, Norway, USA, Canada and Asia/Oceania.

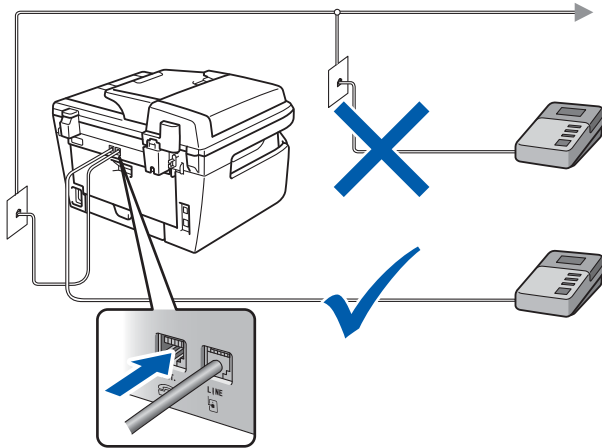

Type B

For the countries such as UK, France, Italy, Belgium, Sweden, Denmark and Finland.

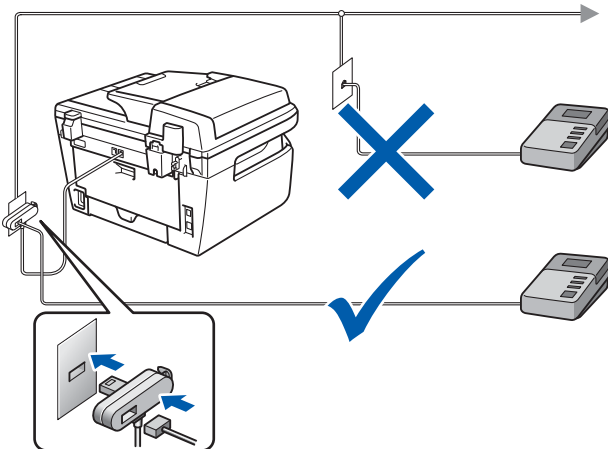

Type C For Germany

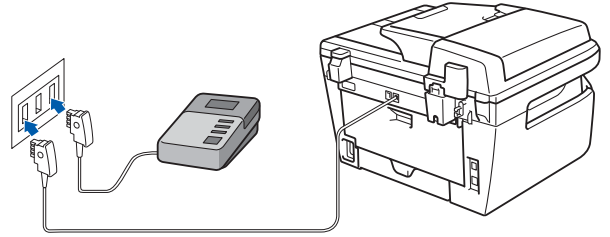

Type D For Switzerland

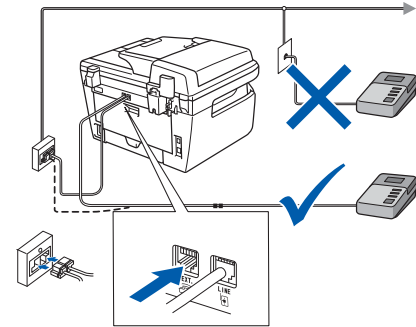

Please set the receive mode to *External TAD*.



For more details, see *Selecting a receive mode* on page 22 and *Connecting an external TAD* in Chapter 7 of the User's Guide.

4 Set Your Country

You must set your country so that the machine works correctly on local telecommunication lines in each country.

- 1 Check that the power is turned on by plugging in the power cord and turn the power switch on. Press **OK**.

```
Set Country
Press OK Key
```

- 2 Press  or  to choose the country. Country names displayed on the **LCD** depend on the modes.

```
Australia
Select ▲▼ or OK
```

- 3 Press **OK** when the LCD shows your country.

- 4 The LCD prompts you to make sure of the country again.

```
Australia?
1.Yes 2.No
```

- 5 If the LCD shows the correct country, press **1** to go to step **6**. Or press **2** to go back to step **2** to choose the country again.

- 6 After the LCD shows *Accepted*, the machine will restart automatically. After the restart, the LCD shows *Please Wait*.

5 Selecting your language (For EU, USA, Canada and Asia)

- 1 Press  **Menu**.
- 2 Press **0**.
- 3 Press **0**.
- 4 Select your language by using  or  and then press **OK**.
- 5 Press  **Stop/Exit**.

6 Setting the date and time

The machine displays the date and time, and if you set up the station ID, it will add it to each fax you send.

- 1 Press  **Menu**.
- 2 Press **0**.
- 3 Press **2**.
- 4 Enter the last two digits of the year on the dial pad, and then press **OK**.

```
Date&Time
Year:2008
```

(e.g. Enter **0, 8** for 2008.)

- 5 Enter the two digits for the month on the dial pad, and then press **OK**.

```
Date&Time
Month:03
```

(e.g. Enter **0, 3** for March.)

- 6 Enter the two digits for the day on the dial pad, and then press **OK**.

```
Date&Time
Day:25
```

(e.g. Enter **2, 5**.)

- 7 Enter the time in 24-hour format on the dial pad, and then press **OK**.

```
Date&Time
Time:15:25
```

(e.g. Enter **1, 5, 2, 5** for 3:25 P.M.)

- 8 Press  **Stop/Exit**.

Note

If you make a mistake and want to start again, press  **Stop/Exit** and go back to step 1.

7 Setting your station ID

You should store your name and fax number to be added on all fax pages that you send.

- 1 Press  **Menu**.
- 2 Press **0**.
- 3 Press **3**.
- 4 Enter your fax number (up to 20 digits) on the dial pad, and then press **OK**. To enter a "+" for international dialling codes, press *. For example, to enter the UK dialling code "+44", press *, **4, 4**, and then the rest of your number.

```
Station ID
Fax:+44XXXXXXXXXX
```



- 5 Enter your tel number (up to 20 digits) on the dial pad, and then press **OK**. (If your telephone number and fax number are the same, enter the same number again.)

```
Station ID
Tel:+44XXXXXXXXXX
```

- 6** Use the dial pad to enter your name (up to 20 characters), and then press **OK**.

Station ID
 Name:

 **Note**

- Refer to the following chart for entering your name.
- If you need to enter a character that is on the same key as the previous character, press  to move the cursor to the right.
- If you entered a letter incorrectly and want to change it, press  or  to move the cursor to the incorrect character, press **C/↶ Clear/Back**.

Press key	One time	Two times	Three times	Four times	Five times
2	A	B	C	2	A
3	D	E	F	3	D
4	G	H	I	4	G
5	J	K	L	5	J
6	M	N	O	6	M
7	P	Q	R	S	7
8	T	U	V	8	T
9	W	X	Y	Z	9

 For more details, see “Entering Text” of the User’s Guide.

- 7** Press  **Stop/Exit**.

 **Note**

(USA only) The Telephone Consumer Protection Act of 1991 makes it unlawful for any person to use a computer or electronic device to send any message via a telephone fax machine unless such messages clearly contain, in a margin at the top or bottom of each transmitted page, or on the first page of the transmission, the date and time it is sent and an identification of the business or other entity or other individual sending the message and the telephone number of the sending machines or such business, other entity or individual. To program this information into your machine, see Setting the date and time on page 20 and Setting your station ID on page 20.

8 Tone and pulse dialling mode

Your machine comes set for Tone dialling service. If you have Pulse dialling service (rotary), you need to change the dialling mode.

- 1** Press  **Menu**.
- 2** Press **0**.
- 3** Press **4**.
- 4** Press  or  to select Pulse (or Tone). Press **OK**.
- 5** Press  **Stop/Exit**.





 **Note**

This Menu is not available for some countries, such as USA, New Zealand, Belgium, Denmark, Sweden, Norway and Finland.

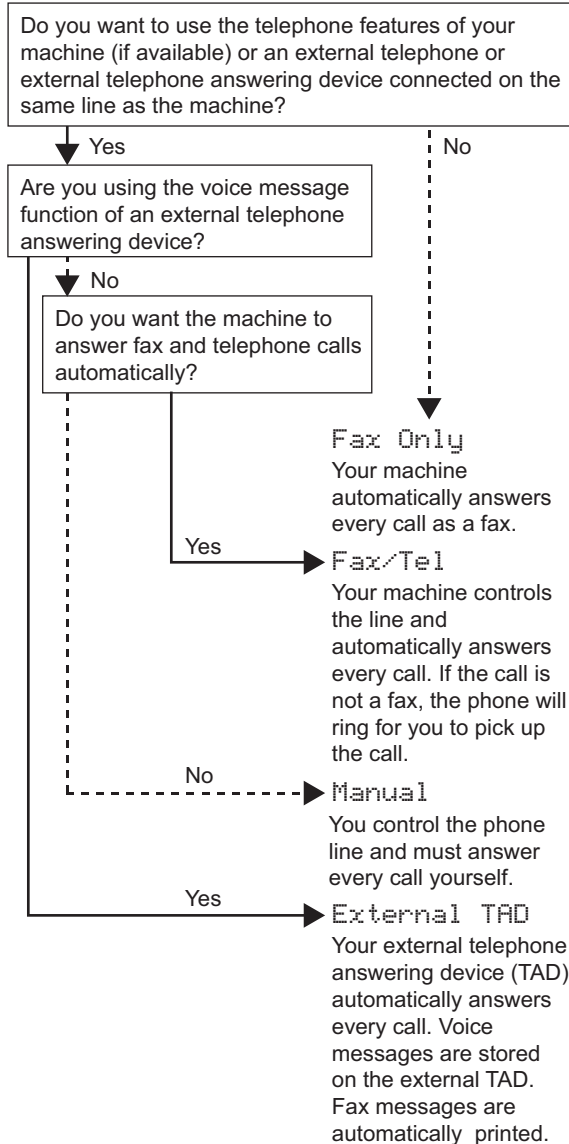
9 Selecting a receive mode

There are four possible receive modes: **Fax Only**, **Fax/Tel**, **Manual** and **External TAD**. Choose the **Receive Mode** which best suits your needs.





- 1** Press  **Menu**.
- 2** Press **0**.
- 3** Press **1**.
- 4** Press  or  to select the mode.
Press **OK**.
- 5** Press  **Stop/Exit**.

 For more details, see *Receiving a fax in Chapter 6 of the User's Guide*.

10 Setting the phone line type (For EU model)

If you are connecting the machine to a line that features a PABX (PBX) or ISDN to send and receive faxes, it is also necessary to change the phone line type accordingly by completing the following steps.

- 1** Press  **Menu**.
- 2** Press **0**.
- 3** Press **6**.
- 4** Press  or  to choose **PBX**, **ISDN** or **Normal**.
Press **OK**.
Do one of the following:
 - If you choose **ISDN** or **Normal**, go to step **8**.
 - If you choose **PBX**, go to step **5**.
- 5** Do one of the following:
 - If you want to change the current prefix number, press **1** and go to step **6**.
 - If you do not want to change the current prefix number, press **2** and go to step **8**.





Note



The default setting is "!". When you press  **Hook**, "!" will be displayed on the LCD.

- 6** Enter the Prefix number (up to 5 digits) on the dial pad, and then press **OK**.





Note

You can use the number 0 to 9, #, * and !.
(Press  **Hook** to display "!.")
You cannot use ! with any other numbers or characters.
If your telephone system requires a timed break recall, press  **Hook** to enter the break.

- 7** Press  or  to choose **On** or **Always** and press **OK**.



Note

- If you choose **On**, pressing  **Hook** (the screen displays "!.") will let you access an outside line.
- If you choose **Always**, you can access an outside line without pressing  **Hook**.

- 8** Press  **Stop/Exit**.



Note

PBX and TRANSFER

The machine is initially set to *Normal*, which lets the machine connect to a standard PSTN (Public Switched Telephone Network) line. However, many offices use a central telephone system or Private Automatic Branch Exchange (PABX). Your machine can be connected to most types of PABX (PBX). The machine's recall feature supports timed break recall only (TBR). TBR will work with most PABX (PBX) systems allowing you to gain access to an outside line, or transfer calls to another extension. The feature works when

Hook is pressed.

11

Setting up the prefix number

The dial prefix setting will automatically dial a predefined number before every fax number you dial. For example: If your telephone system requires a 9 to dial an outside number use this setting to automatically dial 9 for every fax you send.

1

Press **Menu, 0, 6**.

2

Enter the prefix number (up to 5 digits) on the dial pad.
Press **OK**.



Note

- You can use the numbers 0 to 9, #, I and !. (Press **Hook** to display "!".)
You cannot use ! with any other numbers or characters.
If your telephone system requires a timed break recall (hookflash), press **Hook** to enter the break.
- If the pulse dialing mode is on, # and I are not available to use.

3





Press **Stop/Exit**.

12 Changing the prefix number

- 1 Press **Menu**, **0**, **6**.
- 2 Do one of the following:
 - To change the prefix number, press **1**.
 - To exit without making a change, press **2** and go to **4**.
- 3 Enter a new prefix number using the dial pad (up to 5 digits), press **OK**.
- 4 Press **Stop/Exit**.

13 Setting the LCD contrast

You can change the contrast to help the LCD look lighter or darker.

- 1 Press  **Menu**.
 - 2 Press **1**.
 - 3 Press **7**.
 - 4 Press  to increase the contrast.
- OR—
- Press  to decrease the contrast.
 - Press **OK**.
- 5 Press  **Stop/Exit**.

Supplied CD-ROMs for 'SP 1200SF'

Drivers and Utilities for SP 1200SF



Install Multi-Function Suite

You can install the Multi-Function Suite software and multifunction drivers.

Repair Multi-Function Suite (For USB users only)

If an error occurred during the installation of the **Multi-Function Suite**, use this selection to automatically repair and re-install the **Multi-Function Suite**.

Note

Install Multi-Function Suite includes the Printer Driver, Scanner Driver, ControlCenter3.

PaperPort™ 11SE and Documentation for SP 1200SF

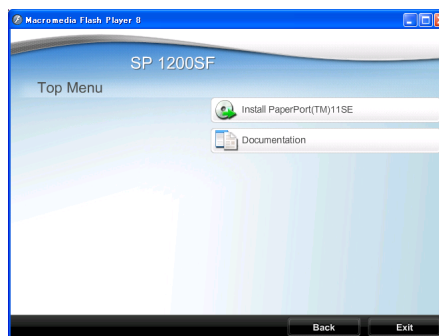

Install Paperport™ 11SE

You can install ScanSoft PaperPort 11SE. ScanSoft™ PaperPort™ 11SE. ScanSoft™ PaperPort™ 11SE is a document management application for scanning and viewing documents.

Documentation

You can view the manuals for SP 1200SF in PDF format.

The Quick Setup Guide, the User Guide and the Software User's Guide. The Software User's Guide includes instructions for features available when connected to a computer. (eg. printing, scanning details)

To save those manuals into your Computer, Click **Install documentation**.

For USB Interface Cable Users

Installing the TYPE 1200SF Drivers and Utilities 28

Installing ScanSoft™ PaperPort™ 11SE for Windows® 30

View and Installing the documentation 31

The screens for Windows® in this Quick Setup Guide are based on Windows® XP.

For USB Interface Cable Users (For Windows® 2000 Professional/XP/7/XP Professional x64 Edition/Windows Vista®)

Installing the TYPE 1200SF Drivers and Utilities

Important

Make sure that you have finished the instructions from step 1 *Setting Up the Machine* on pages 15 through 24.

Note

- Please close any applications running before installing the Multi-Function Suite.
- Please update to the latest Windows® Service Pack before installing Multi-Function Suite.
- Be sure to use the CD-ROM titled "Drivers and Utilities for SP 1200SF"

- 1 Turn off and unplug the machine from the AC outlet and disconnect it from your computer, if you already connected an interface cable.

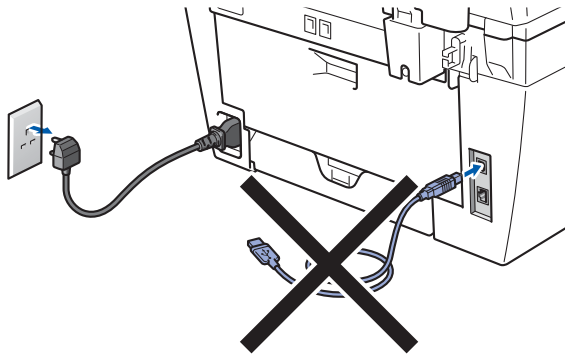

- 2 Turn on your computer. (You must be logged on with administrator rights.)

- 3 Put the supplied CD-ROM for Windows® into your CD-ROM drive. If the model name screen appears, choose your machine. If the language screen appears, choose your language.

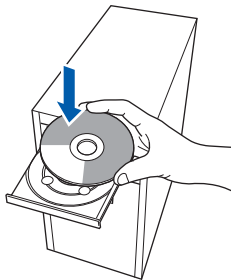

- 4 The CD-ROM main menu will appear. Click **Install Multi-Function Suite**.

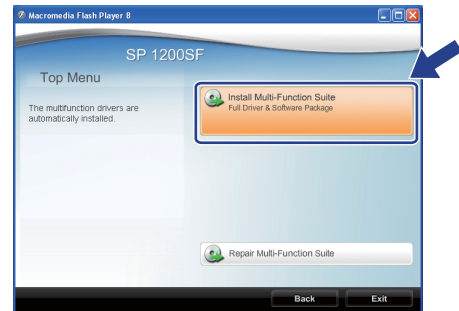

Note

- If this window does not appear, use Windows® Explorer to run the **start.exe** program from the root folder of the CD-ROM.
- For Windows Vista®, when the User Account Control screen appears, click **Allow**.

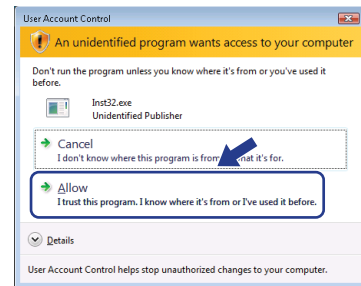

- For Windows® 7, when the User Account Control Dialog box appears on your computer, click **Yes**.

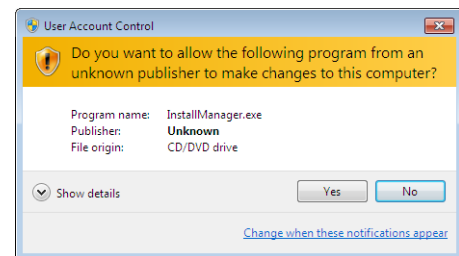

- 5 When the Multi-Function Suite Software License Agreement window appears, click **Yes** if you agree to the Software License Agreement.

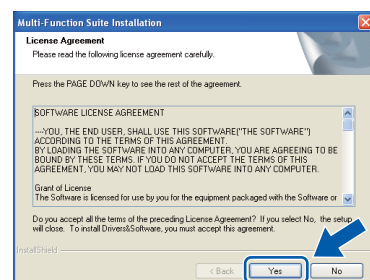

Installing the Driver & Software

- 6 Choose **Standard** and then click **Next**. The installation will continue.

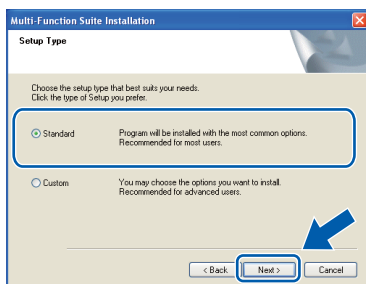

- 7 When this screen appears, connect the USB interface cable to your PC, and then connect it to the machine.

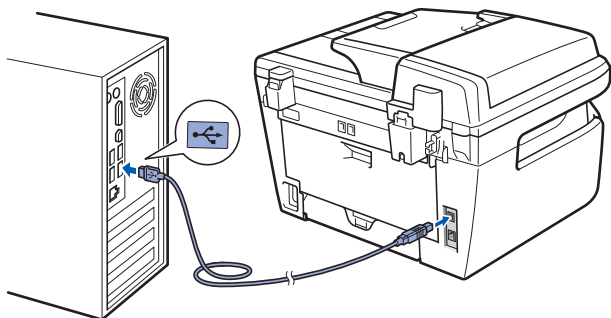
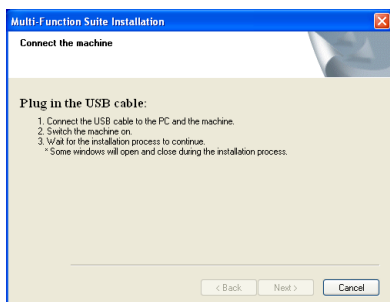

Improper Setup

DO NOT connect the machine to a USB port on a keyboard or a non-powered USB hub. We recommend that you connect the machine directly to your computer.

- 8 Plug the AC power cord into an AC outlet. Turn the power switch on.

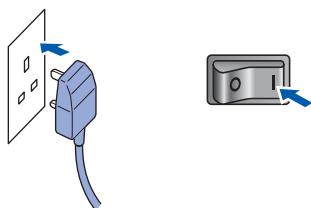

The installation of the drivers will automatically start. **The installation screens appear one after another, please wait for a while.**

Improper Setup

DO NOT try to cancel any of the screens during this installation.

- 9 Click **Finish** to restart your computer. (After restarting the computer, you must be logged on with Administrator rights.)

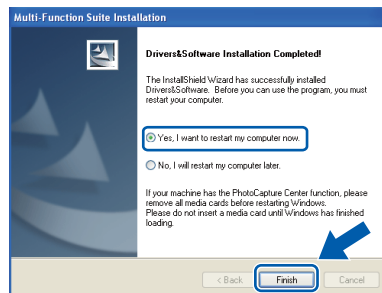

Note

After restarting the computer, the **Installation Diagnostics** will run automatically. If the installation is unsuccessful, the installation results window will be shown. If the **Installation Diagnostics** shows a failure, please follow the on-screen instruction.



The Multi-Function Suite (including printer driver and scanner driver) has been installed and the installation is now complete.

Installing ScanSoft™ PaperPort™ 11SE for Windows®

Important

Make sure that you have finished the instructions for installing TYPE 1200SF Drivers and Utilities on pages 28 through 29.

Note

Be sure to use the CD-ROM titled "PaperPort™ 11SE and Documentation SP 1200SF"

- Put the supplied CD-ROM for Windows® into your CD-ROM drive. If the model name screen appears, choose your machine. If the language screen appears, choose your language.

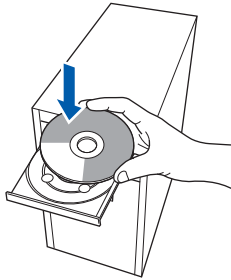

- The CD-ROM Top menu will appear. Click Install Paperport(TM) 11SE.

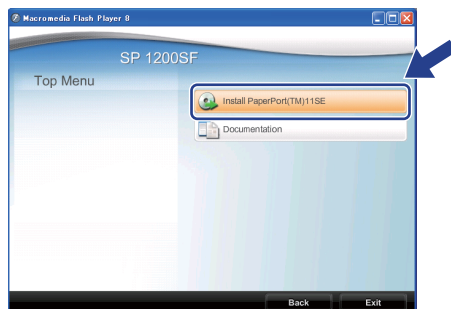

Note

- If this window does not appear, use Windows® Explorer to run the **start.exe** program from the root folder of the CD-ROM.
- For Windows Vista®, when the User Account Control screen appears, click **Allow**.

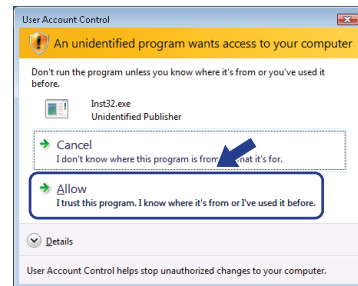

- For Windows® 7, when the **User Account Control Dialog box** appears on your computer, click **Yes**.

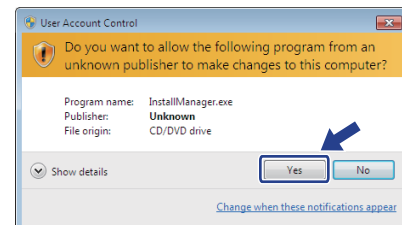

- After reading and accepting the ScanSoft™ PaperPort™ 11SE License Agreement, click **Yes**.

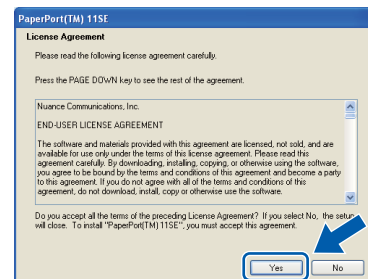

The installation of ScanSoft™ PaperPort™ 11SE will automatically start and finish.

Installing the Driver & Software

View and Installing the documentation

Important

Make sure that you have finished the instructions for installing TYPE 1200SF Drivers and Utilities on pages 28 through 29.

Note

Be sure to use the CD-ROM titled "PaperPort™ 11SE and Documentation SP 1200SF"

- 1 Put the supplied CD-ROM for Windows® into your CD-ROM drive. If the model name screen appears, choose your machine. If the language screen appears, choose your language.

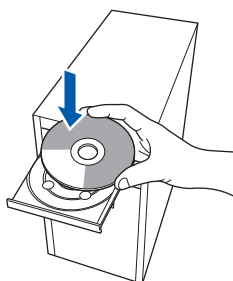

- 2 The CD-ROM Top menu will appear. Click Documentation.
- 3 You can view the manuals for SP 1200SF in PDF format. The Quick Setup Guide, the User Guide and the Software User's Guide. The Software User's Guide includes instructions for features available when connected to a computer. (eg. printing, scanning details) To save those manuals into your Computer, Click **Install documentation**.

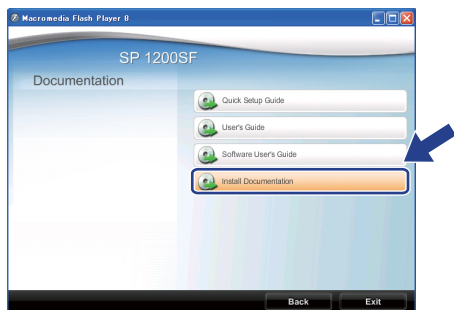

Note

- If this window does not appear, use Windows® Explorer to run the **start.exe** program from the root folder of the CD-ROM.
- For Windows Vista®, when the User Account Control screen appears, click **Allow**.

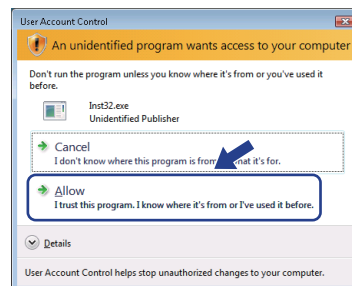

- For Windows® 7, when the **User Account Control Dialog box** appears on your computer, click **Yes**.

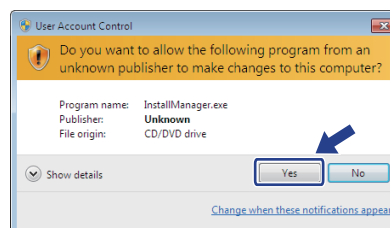

Consumables

When the time comes to replace consumable items, an error message will be indicated on the LCD. For more information about the consumables for your printer, contact your sales or service representative.

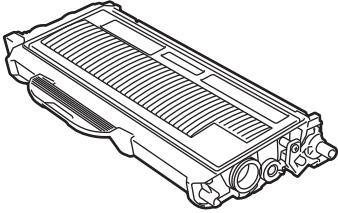
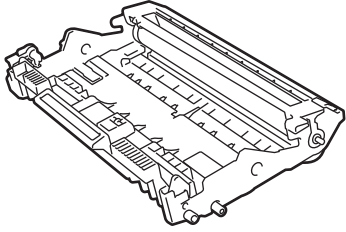
Toner Cartridge	Drum Unit
Print Cartridge SP 1200E (for Europe) Print Cartridge SP 1200A (USA and Canada) Print Cartridge SP 1200S (For Asia)	Drum Unit SP 1200 (Approx. 12,000 pages A4/Letter pages)
	

¹ Approx. cartridge yield is declared in accordance with ISO/IEC 19752.

Trademarks

All brand and product names mentioned in this manual are registered trademarks of their respective companies.
Copyright © 2011 Ricoh Co., Ltd. All Rights Reserved.

